

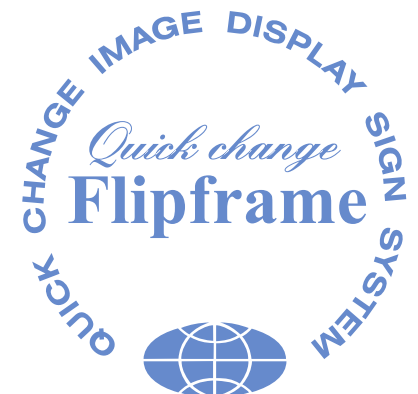

2009 commercial extrusions

Toll free 1-800-465-8004 [www.signalex.com](http://www.signalex.com)





# BSH Series extrusions

## BSH SINGLE SIDED CABINETS

**BSHF-R680 Regular**

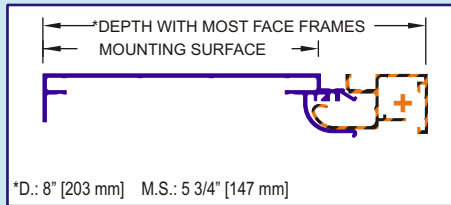

**BSHF-S350 Small**

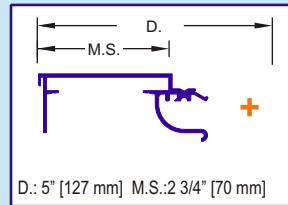

**BSHF-W850 Wide**

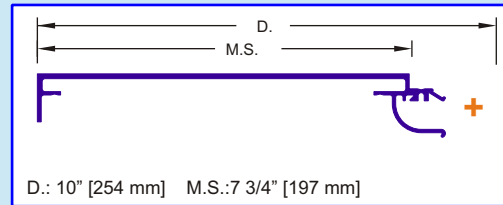

**E-7002 Retfit Self Hinge**

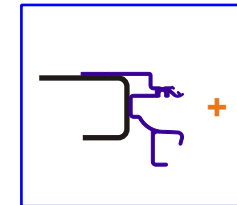

## BSH DOUBLE SIDED CABINETS

**BSHD-R8740 Regular**

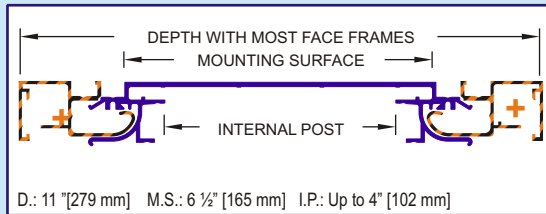

**BSHD-M1020 Medium**

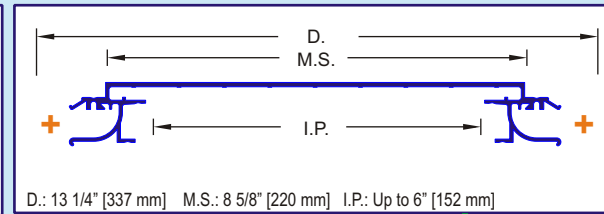

**BSHD-W1300 Wide**

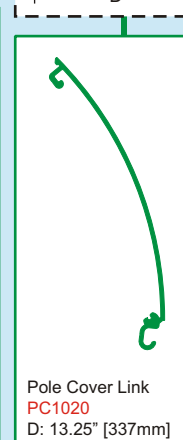
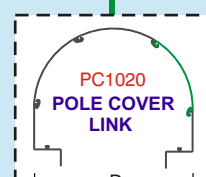
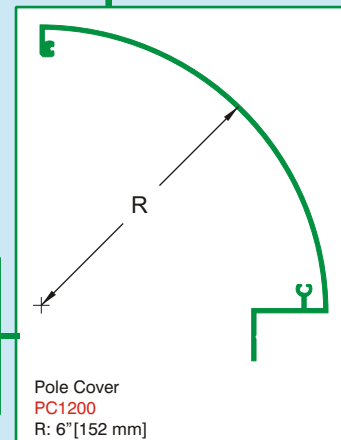
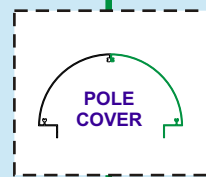
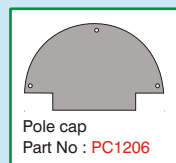
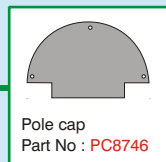
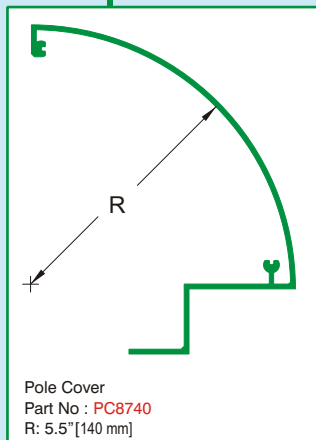
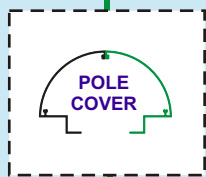
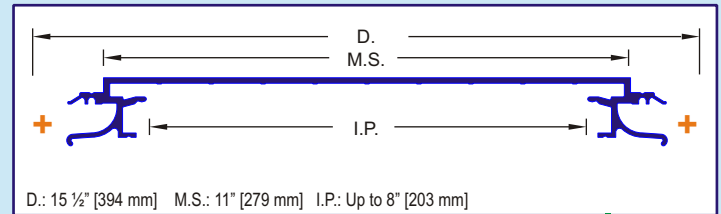

WORKS WITH

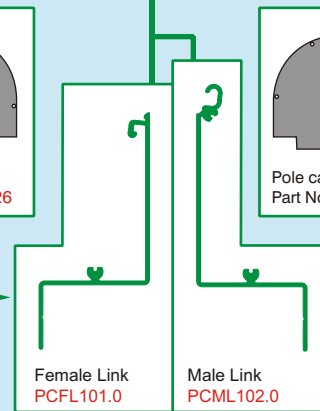
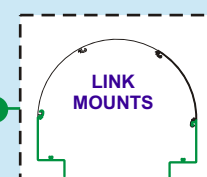

WORKS WITH

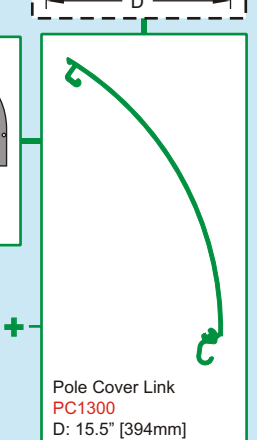
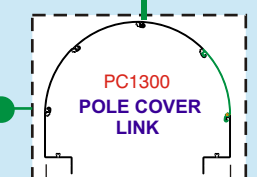

## BSH FACE FRAMES FOR PLASTIC GRAPHIC FACES

**BSH SELF HINGING FRAMES**

BSH1250    BSH2000    BSH6250    BSH1500    BSH1800

F: 1 1/4" [32 mm]

**RETROFIT FRAMES**

E-R1150    E-R2000    RET1800

F: 1 1/2" [38 mm]    F: 2" [51 mm]    F: 5/8" [16 mm]    F: 1 1/2" [38 mm]    F: 2" [51 mm]

## FOR MULTI PANEL GRAPHIC FACES

**BSH SELF HINGING FRAMES**

BSH1260    BSH2060    1270 H-Dividers    2070

F: 1 1/4" [32 mm]    F: 2" [51 mm]    F: 1 1/4" [32 mm]    F: 2" [51 mm]

## BSH FACE FRAMES FOR VINYL GRAPHIC FACES

**BSH SELF HINGING FRAMES**

BSH-SR2010    BSH-SR2520    BSH1950    BSH1970

**RETROFIT FRAMES**

SR2110    SR2510    1960    1980

FRAMELESS    F: 1 1/2" [38 mm]    F: 1 7/8" [48 mm]    FRAMELESS

## FACE FRAMES OTHER

BSH1100    1700    FLS2010

HINGE ON HINGE    ALUMINUM FACE    F: 2" [51 mm]    FRONT LOAD VINYL

**VA0006 BRACE BRACKET**    **VA2006 BRACE BRACKET**    **1406 BRACE BRACKET**    **1996 BRACE BRACKET**

**1968 BRACE**    **1967**

**WORKS WITH**

**WORKS WITH**

# PHplus extrusions

## PHP SINGLE SIDED CABINETS

PHP4000

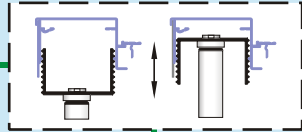
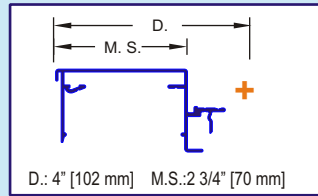

PHP4009 Adjustable raceway cover  
 D: 1" [25 mm] W: 1 3/4" [44 mm]

PHP5500

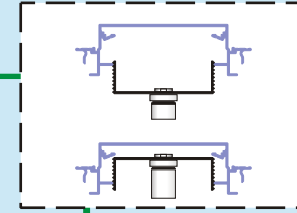
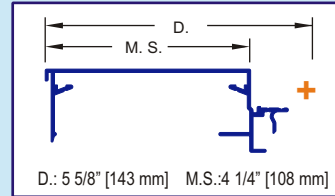

UN5579 Adjustable raceway cover  
 D: 1" [25 mm] W: 3 1/2" [89 mm]

## PHP DOUBLE SIDED CABINET

PHP7000

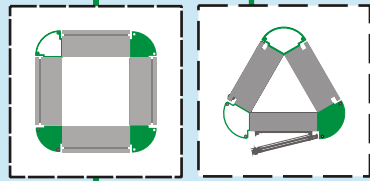
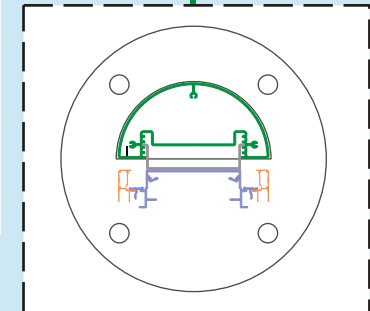
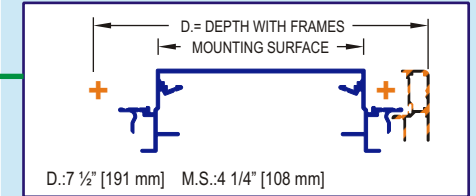

PHP4250 90° Post  
 R: 4" [102 mm]

PHP4256 Post cap  
 PHP4336 Post cap

PHP4330 120° Post  
 R: 4" [102 mm]

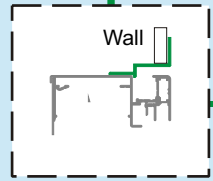

PHP1000 Wall trim frame

PHP7508 Base plate casting  
 D: 12" [305 mm]  
 C: Bolt centers 7" [178 mm]  
 Thickness 3/4" [19 mm]

PHP7500 Post  
 D: 7" [178 mm]

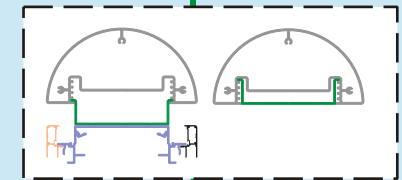

PHP7510 Adjustable Post Cover  
 R: 6" [152 mm]

WORKS WITH

## PHP SINGLE SIDED RETAINER.

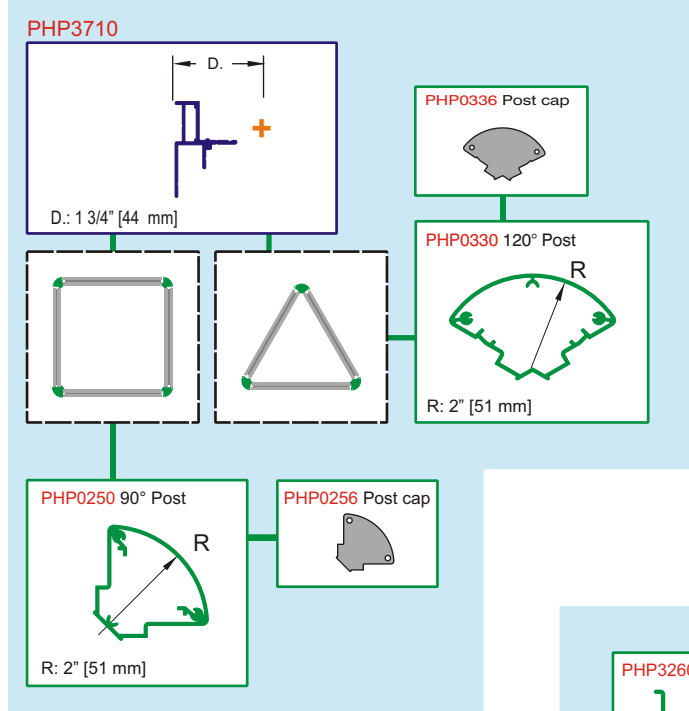

## PHP DOUBLE SIDED RETAINER

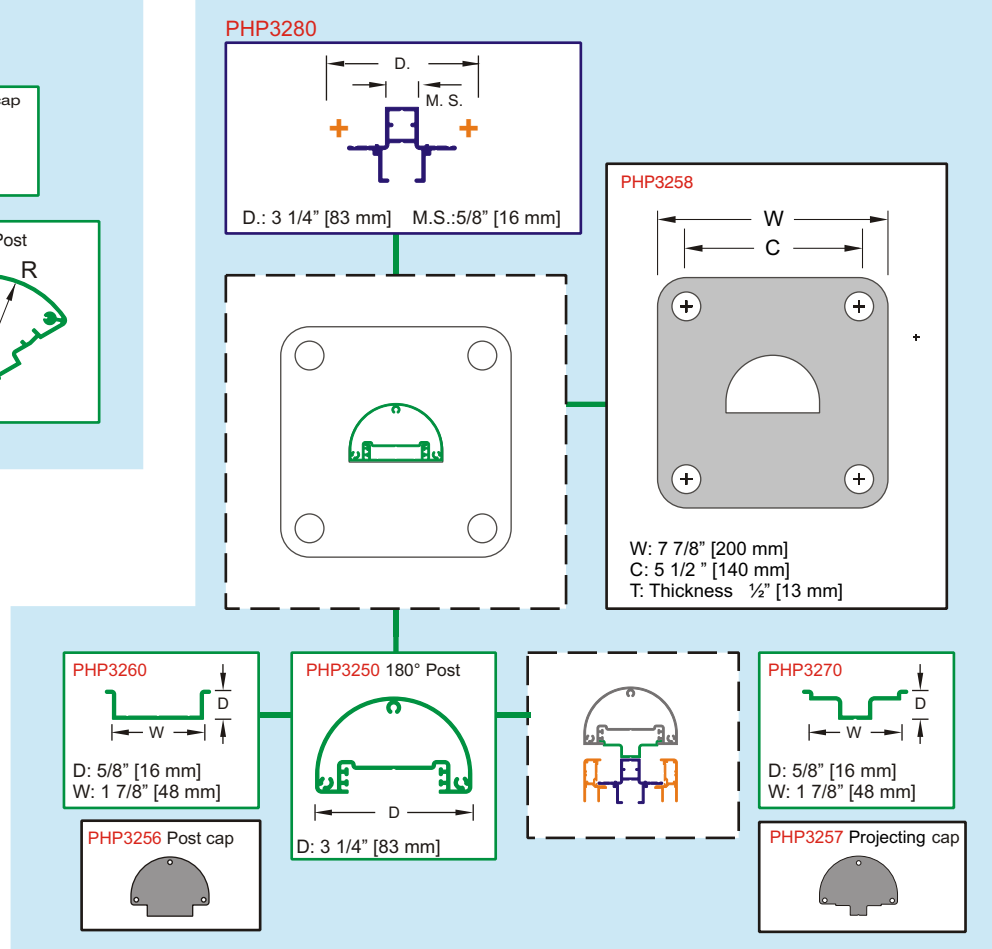

## PHP FACE FRAMES

Not to scale

**PHP3730**

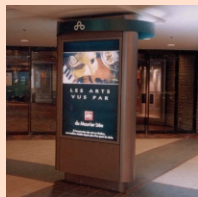

P13-B  
F: 1 1/2" [38 mm]  
3/16" [5 mm] plastic  
or tempered glass

**PHP3740**

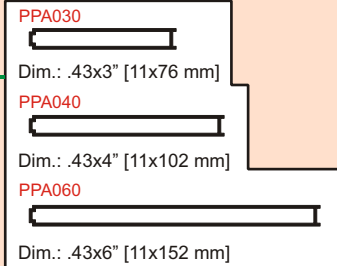

P15-B  
F: 1 1/2" [38 mm]  
0.43" [11 mm]  
Aluminum panels

**PHP3750**



P17-B  
F: 1/8" [3 mm]  
1/8" aluminum sheet

# Flip frame extrusions

## SINGLE AND DOUBLE SIDED CABINETS.

**PFPS3510**

D.: 3 1/2" [89 mm] M.S.: 3" [76 mm]

**PFPD4110**

D.: 4" [102 mm] M.S.: 3 1/4" [82 mm]

**PPRW Adjustable raceway cover**

D: 5/8" [16 mm] W: 3 3/8" [86 mm]

## SINGLE & DOUBLE SIDED RETAINERS.

**MID750**

D.: 1" [25 mm]

**MID110**

D.: 1 3/8" [35 mm]

## MIDI FLIP FRAME.

**MID120**

F: 1 1/4" [32 mm]

WORKS WITH

## MAXI FLIP FRAMES.

**MAX250**

F: 2.5" [63 mm]

**MAX250i**

F: 2.5" [63 mm] I: 2" [51 mm]

WORKS WITH

## MINI RETAINER.

**MIN050**

D.: 1/2" [13 mm]  
M.S.: 1/4" [6 mm]

## MINI FLIP FRAME.

**MIN100**

F: 1" [25 mm]

WORKS WITH