

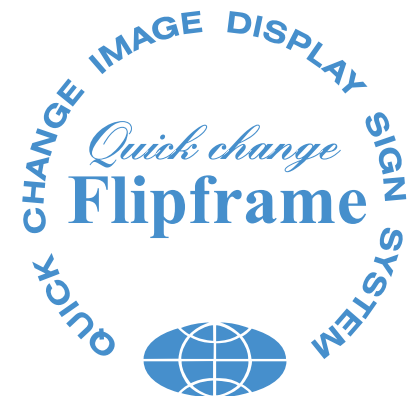

2010 commercial extrusions

Toll free 1-800-465-8004 www.signalex.com





BSH Series extrusions

BSH SINGLE SIDED CABINETS

BSHF-R680 Regular

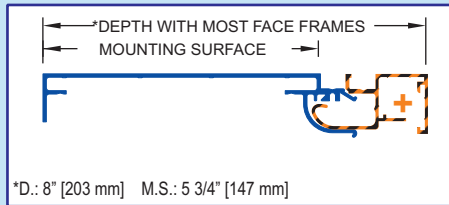

BSHF-S350 Small

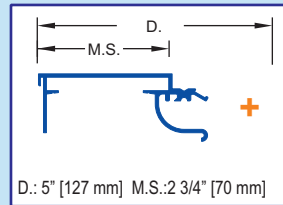

BSHF-W850 Wide

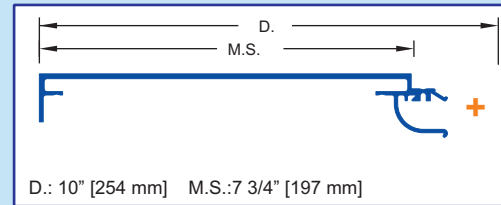

E-7002 Retfit Self Hinge

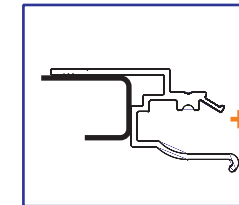

BSH DOUBLE SIDED CABINETS

BSHD-R8740 Regular

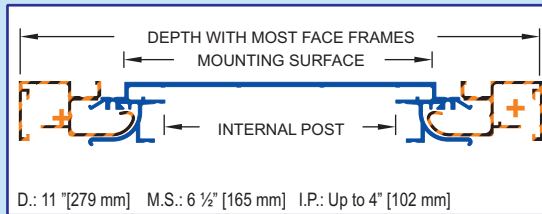

BSHD-M1020 Medium

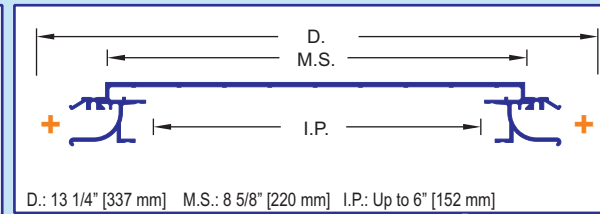

BSHD-W1300 Wide

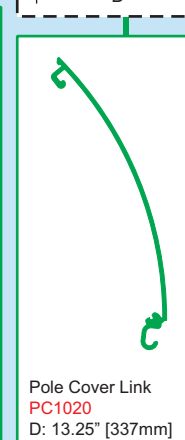
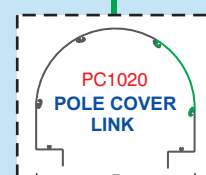
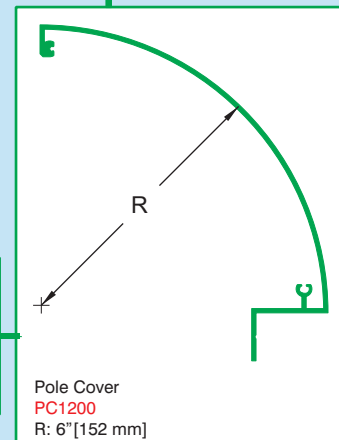
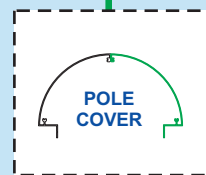
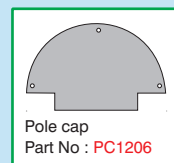
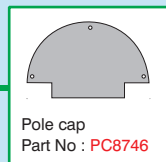
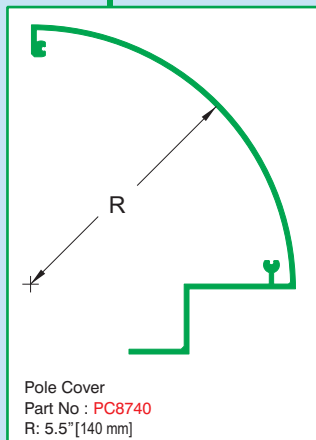
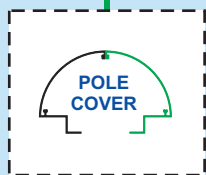
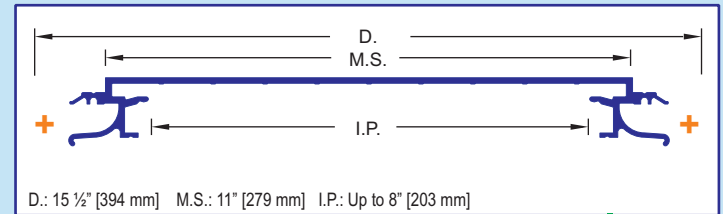

WORKS WITH

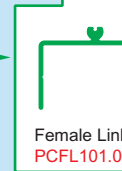
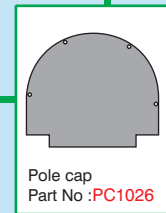
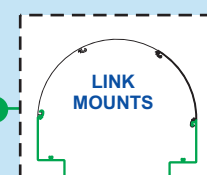

WORKS WITH

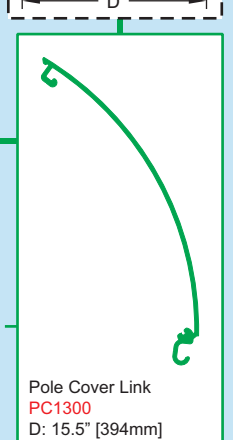
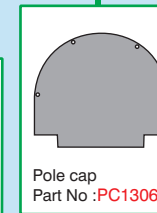
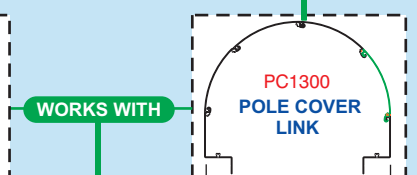

BSH FACE FRAMES FOR PLASTIC GRAPHIC FACES

BSH SELF HINGING FRAMES

BSH1250 **BSH2000** **BSH6250** **BSH1500** **BSH1800**

F: 1 1/4" [32 mm]

RETROFIT FRAMES

E-R1150 **E-R2000** **RET1800**

F: 1 1/2" [38 mm] F: 2" [51 mm] F: 5/8" [16 mm] F: 1 1/2" [38 mm] F: 2" [51 mm]

FOR MULTI PANEL GRAPHIC FACES

BSH SELF HINGING FRAMES

BSH1260 **BSH2060** **1270 H-Dividers** **2070**

F: 1 1/4" [32 mm] F: 2" [51 mm] F: 1 1/4" [32 mm] F: 2" [51 mm]

BSH FACE FRAMES FOR VINYL GRAPHIC FACES

BSH SELF HINGING FRAMES

BSH-SR2010 **BSH-SR2520** **BSH1950** **BSH1970**

RETROFIT FRAMES

SR2110 **SR2510** **1960** **1980**

FRAMELESS F: 1 1/2" [38 mm] F: 1 7/8" [48 mm] FRAMELESS

FACE FRAMES OTHER

BSH1100 **1700** **FLS2010**

RETROFIT

F: 2" [51 mm] FRONT LOAD VINYL

VA0006 BRACE BRACKET **VA2006 BRACE BRACKET** **1406 BRACE BRACKET** **1996 BRACE BRACKET**

1968 BRACE **1967**

WORKS WITH

WORKS WITH

PHPlus extrusions

PHP SINGLE SIDED CABINETS

PHP4000

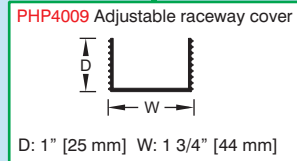
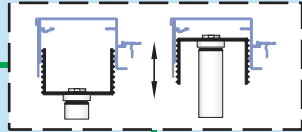
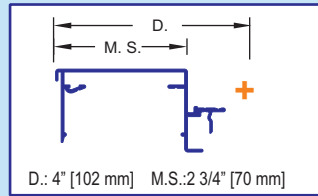

PHP5500

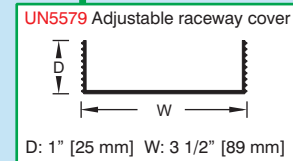
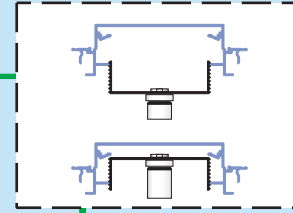
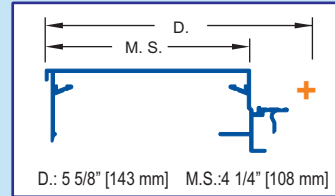

PHP DOUBLE SIDED CABINET

PHP7000

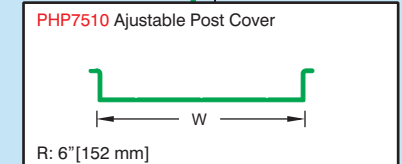
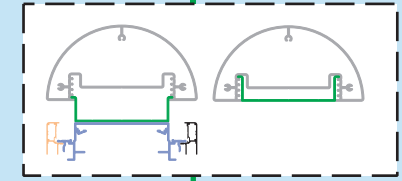
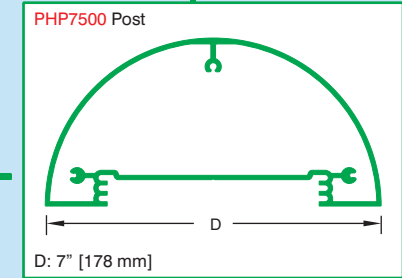
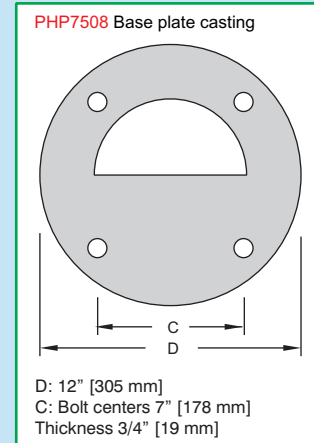
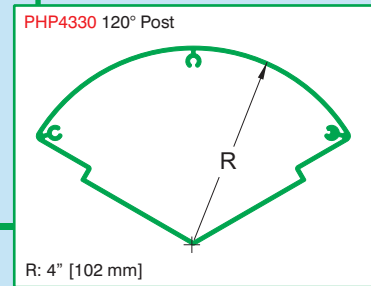
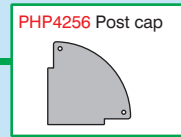
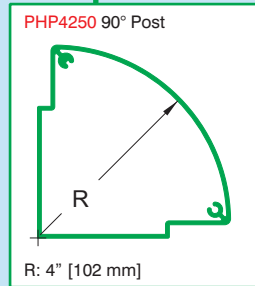
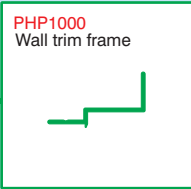
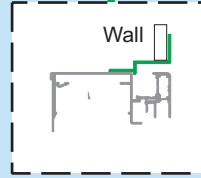
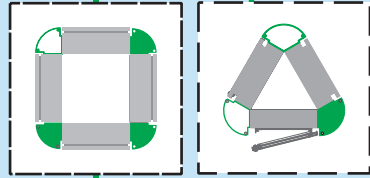
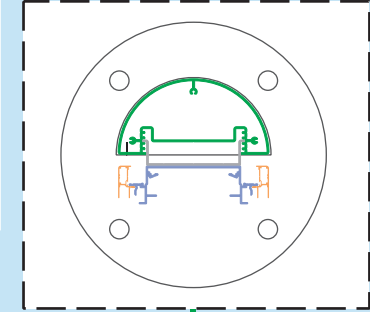
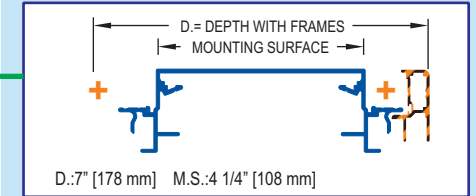

PHP SINGLE SIDED RETAINER.

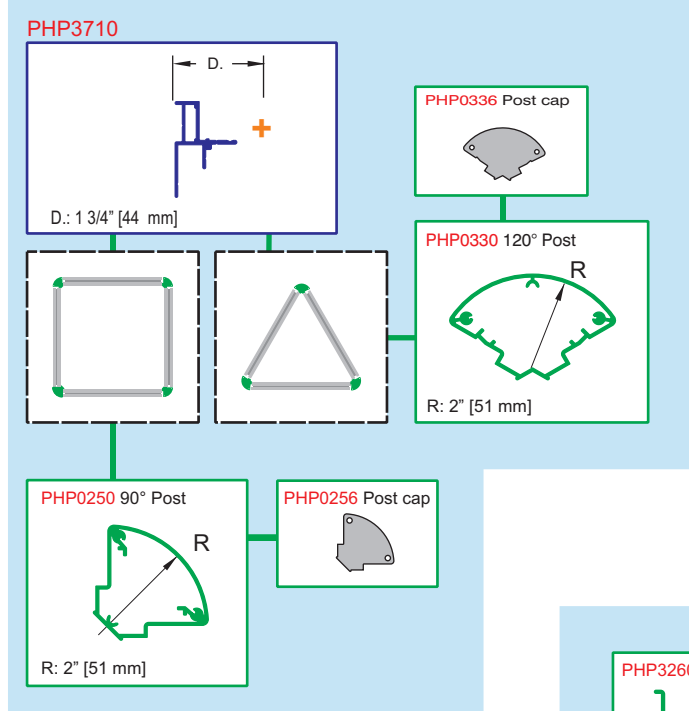

PHP DOUBLE SIDED RETAINER

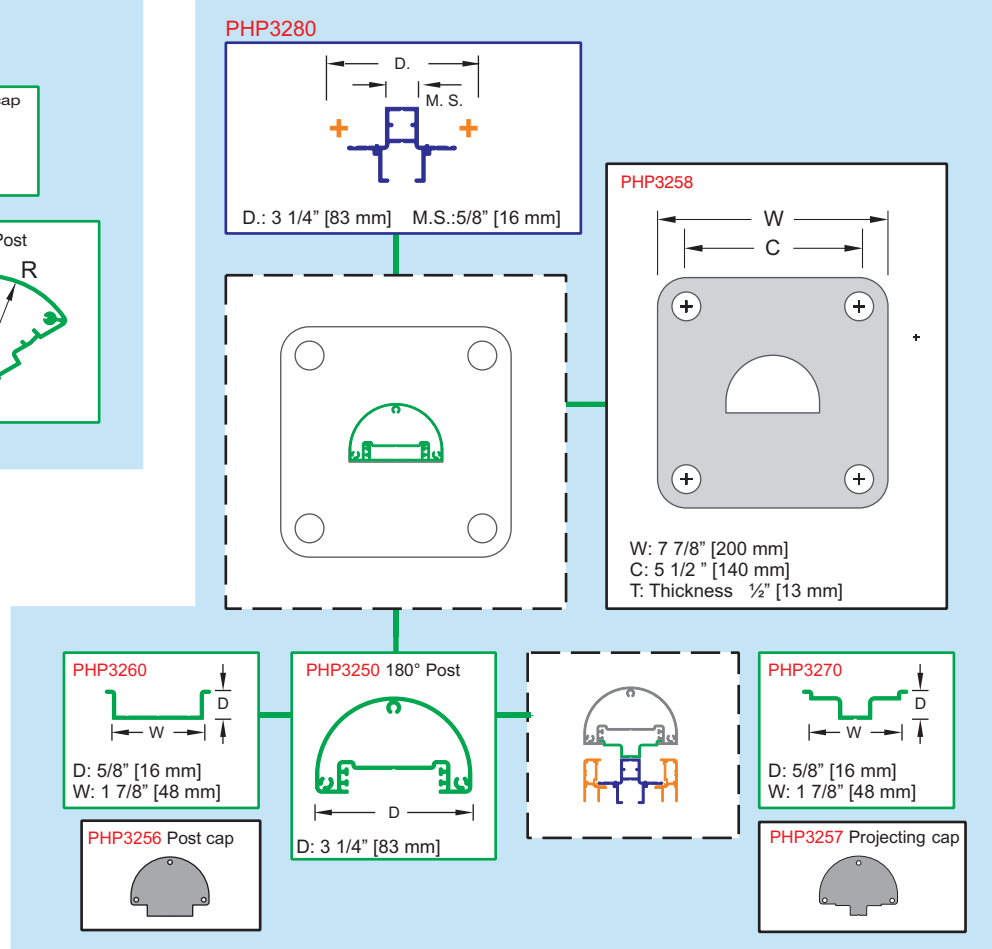

PHP FACE FRAMES

Not to scale

PHP3730

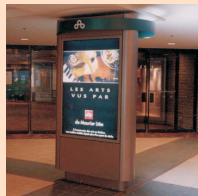

P13-B
F: 1 1/2" [38 mm]
3/16" [5 mm] plastic
or tempered glass

PHP3740

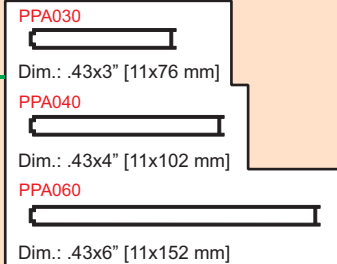

P15-B
F: 1 1/2" [38 mm]
0.43" [11 mm]
Aluminum panels

PHP3750



P17-B
F: 1/8" [3 mm]
1/8" aluminum sheet



Flip frame extrusions

SINGLE AND DOUBLE SIDED CABINETS.

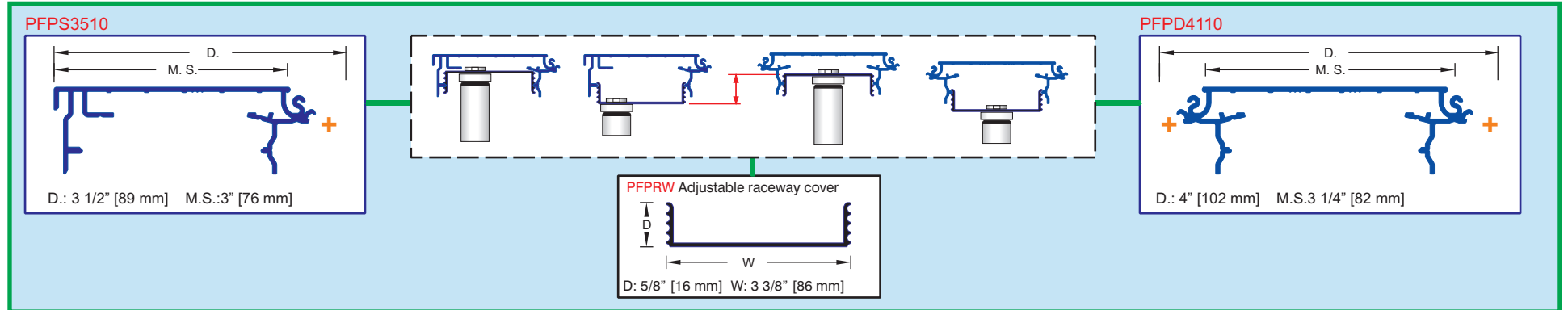

SINGLE & DOUBLE SIDED RETAINERS.

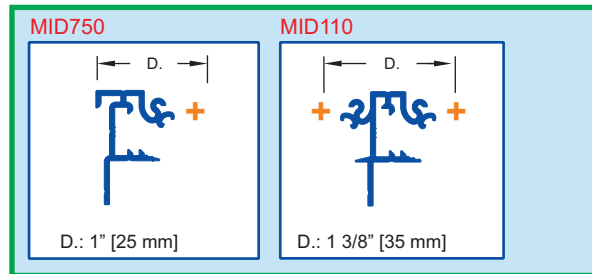

MIDI FLIP FRAME.

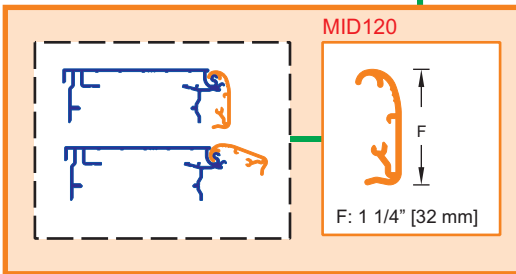

WORKS WITH

MAXI FLIP FRAMES.

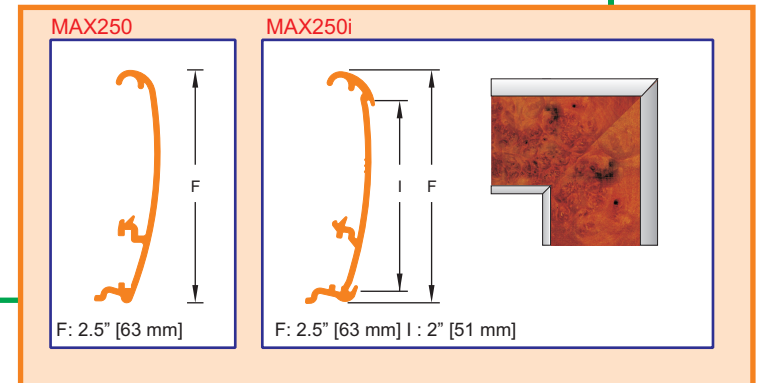

WORKS WITH

MINI RETAINER.

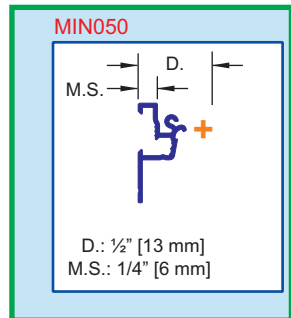

MINI FLIP FRAME.

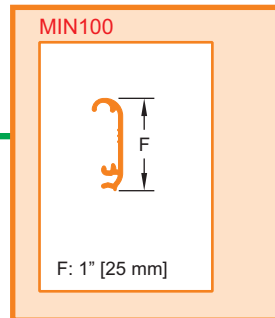

WORKS WITH